

## GENERAL MAINTENANCE

Periodic cleaning of projector assembly is required to maintain crisp, clean images. Remove dust from mirror and projection screen using a soft cloth treated with anti-static compound (endust, etc.). Observe caution tag on cleaning mirrors, as they are easy to scratch.

Remove metal dust cover from projector and carefully vacuum any dust accumulation. Film loop may require cleaning and should only be wiped with soft, damp rag. DO NOT remove film loop from projector except to replace it. (See instructions elsewhere).

Remove air intake duct and vacuum interior of projector. Use a soft cloth to wipe the two glass lenses mounted inside. It is not necessary to clean projection lense. DO NOT remove or loosen projection lense from mount. To do so could change the focusing of the unit and cause blurry images.

## FOCUSING PROJECTOR

Re-focusing the projector should not be required unless film loop has been replaced or if projector was moved or taken from cabinet.

1. Remove terrain scenery from cabinet (pull spring pins inward to free frame.)
2. Remove dust cover from projector.
3. Loosen set screw on projection lense mount. (See Figure 1)
4. Start game and observe images on screen. Sharpest images should be 1/2 to 3/4 of distance up the screen. To adjust focus, place projector service switch in "Off" position with full flight of aircraft on screen. Adjust lense by moving in or out of mount, a slight movement should be sufficient. Tighten lock screw just enough to prevent movement of lense barrel.

CAUTION: Over tightening could distort or break the lense.

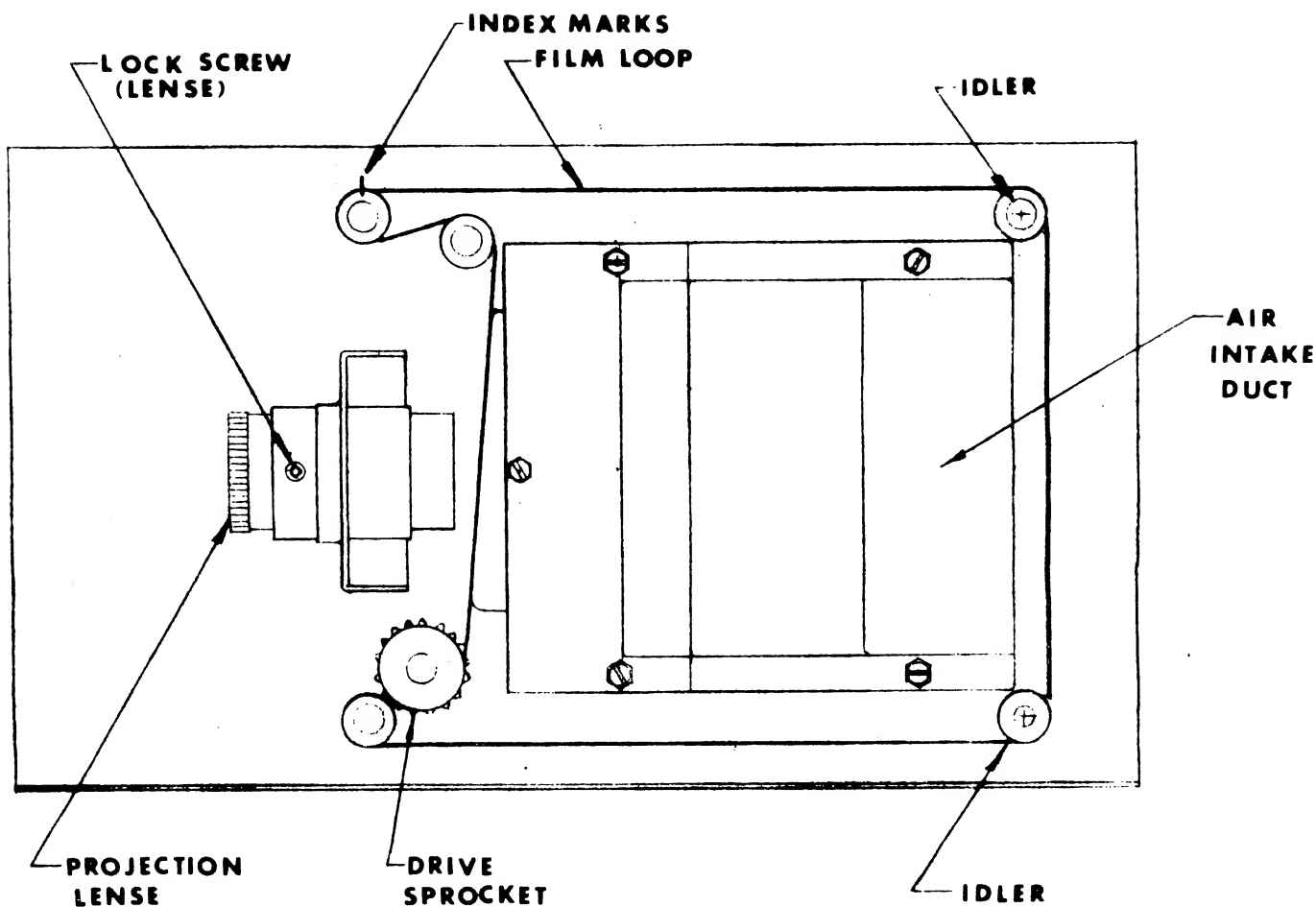

Fig. 1

### R E P L A C I N G   F I L M   L O O P

To replace film loop, remove dust cover and remove idler post at top rear of projector (screws are near fan housing) so that film is slack. Observe film path so that new film is located properly. Insert new film (shiny side in) starting with drive sprocket, making sure sprocket teeth engage film slots. Insert film between projection lense and projector face and then up and around upper front idlers. Now, work film around lower rear idler and finally upper rear idler. Before replacing dust cover, operate projector and check images on screen for proper focus. If images are blurred, follow focusing instructions on Page 1.

## P R O J E C T O R    A L I G N M E N T

### ZERO POSITION ALIGNMENT

If at any time the film loop has been removed from the projector or film perforations shifted with respect to the drive sprocket, it will be necessary to align the film with respect to the commutator printed circuit disc on the side of the projector. Proceed as follows:

1. Remove terrain scenery from cabinet per instruction tag.
2. Start game and observe images on screen. When zero position aircraft (as indicated in Figure 2) begins approaching zero position alignment darts on screen (see Figure 4), place projector service switch in "Off" position.
3. Images can be moved on screen manually by rotating brass gear in projector drive motor (do not attempt to rotate sprocket shaft or wiper shaft either by hand or with tools). Adjust zero position aircraft so that nose of aircraft is in line with darts on screen as shown in Figure 4. Some projectors will have a painted index mark on the film that will line up with a mark on upper forward Idler Bracket or Idler Post (see Figure 1).
4. Long leaf of wiper on commutator printed circuit disc should be in center of Segment "E" at zero position (see Figure 3).

Fine adjustment of zero position is made by shifting commutator printed circuit disc. Rough adjustment is made by loosening wiper finger and positioning wiper as required.

### IMAGE ALIGNMENT ON SCREEN

In order to score hits on the aircraft, the aircraft images must follow a pre-determined path on the screen. These paths are indicated on the uppermost part of the projection screen (see Figure 4). The zero position aircraft should pass through the vertical alignment dart (referenced "E" in Figure 4) within a 1/4" of each side of the dart.

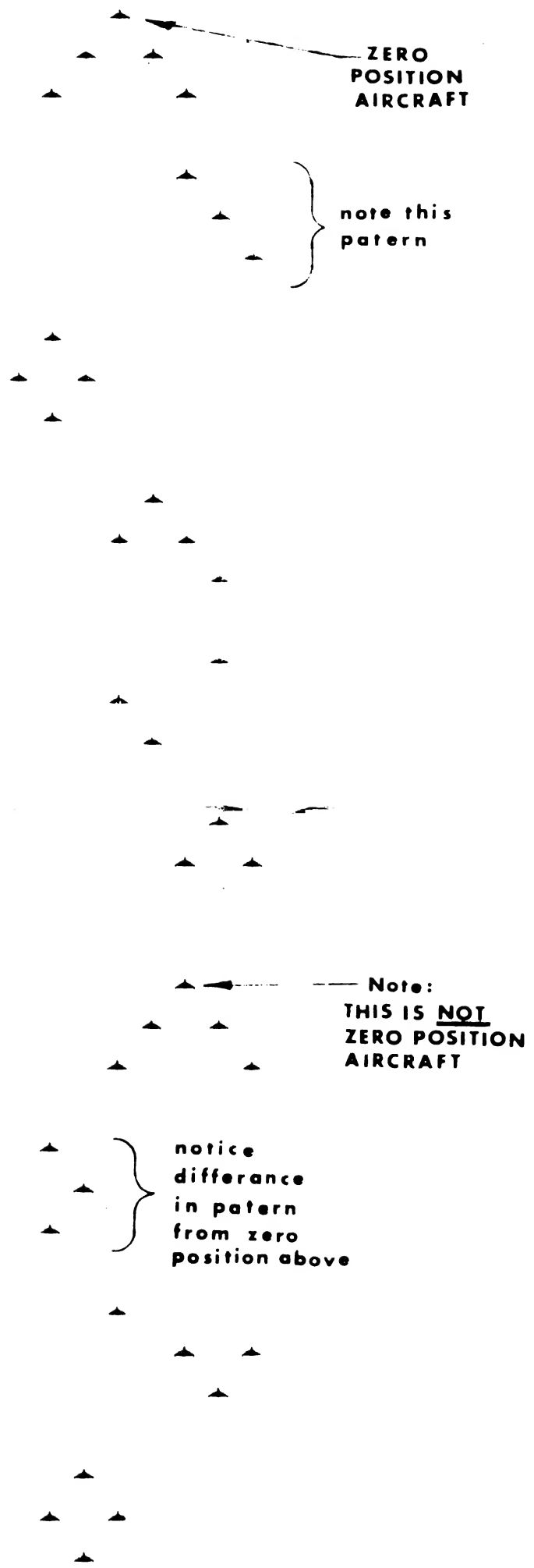

Fig. 2

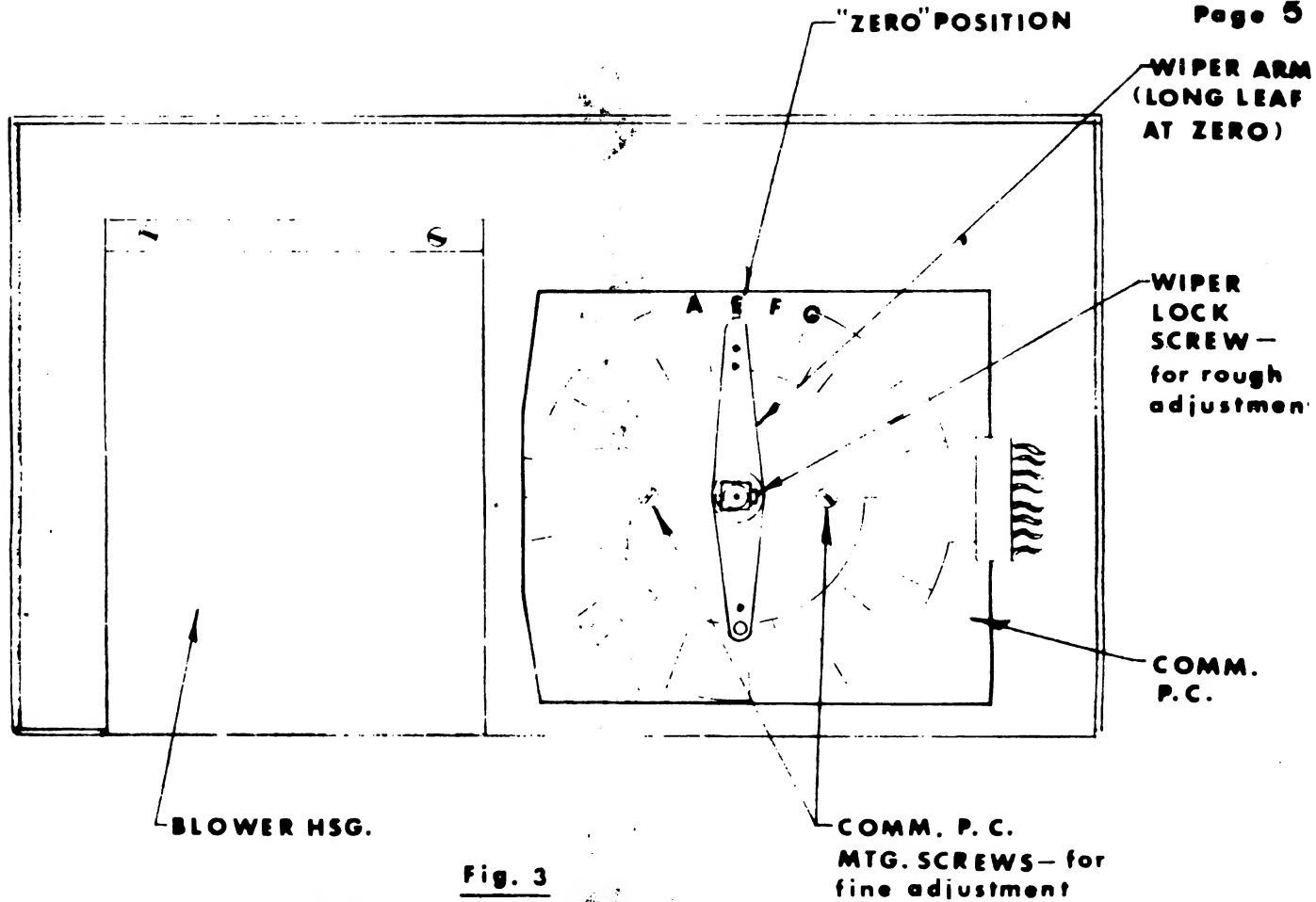

Fig. 3

VERTICAL ALIGNMENT DARTS

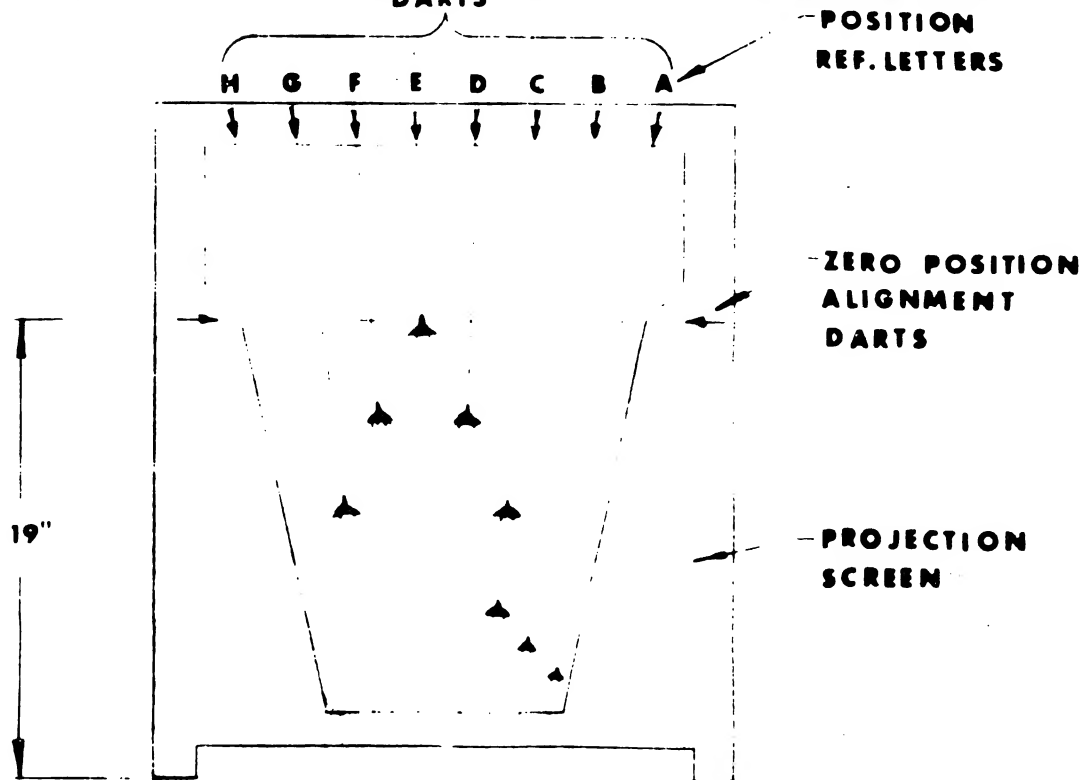
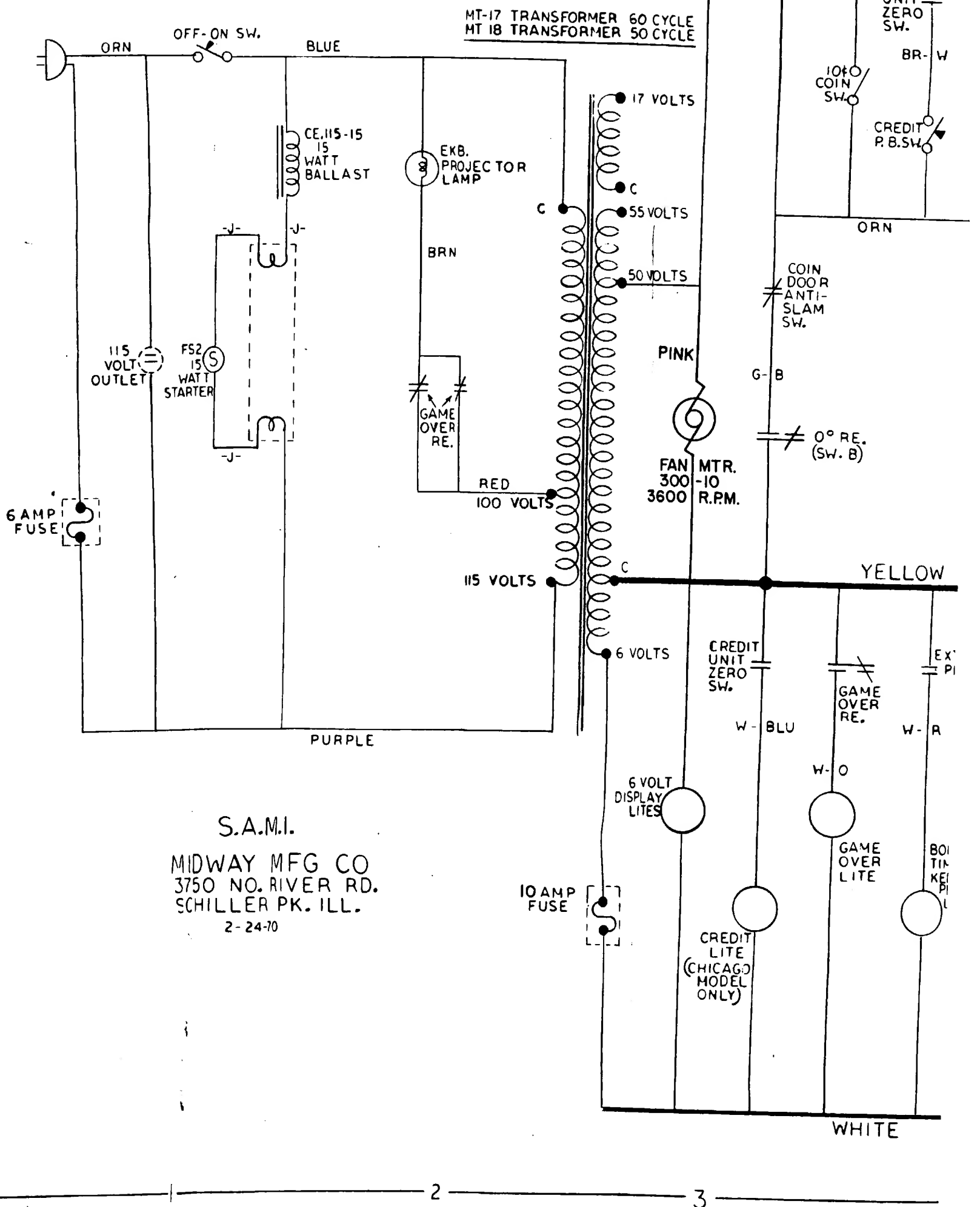

Fig. 4

WIRE COLOR CODE		SWITCH SYMBOLS
B=BLACK	O=ORANGE	"NORMALLY OPEN" CLOSED WHEN ENERGIZED.
BLU=BLUE	R=RED	"NORMALLY CLOSED" OPEN WHEN ENERGIZED.
BR=BROWN	W=WHITE	MAKE & BREAK
G=GREEN	Y=YELLOW	MOTOR CAM SWITCH
<b>EXAMPLE</b> G-R INDICATES GREEN WIRE WITH RED TRACER		1 MFD. CAPACITOR
<b>ABBREVIATIONS USED</b>		
J=JUMPER	SW=SWITCH	
RE=RELAY	POS=POSITION	
SU=STEP UP UNIT		
OSC=OSCILLATING		



S.A.M.I.  
MIDWAY MFG CO  
3750 NO. RIVER RD.  
SCHILLER PK. ILL.  
2-24-70

A  
B  
C  
D  
E  
F

2 3

BLACK

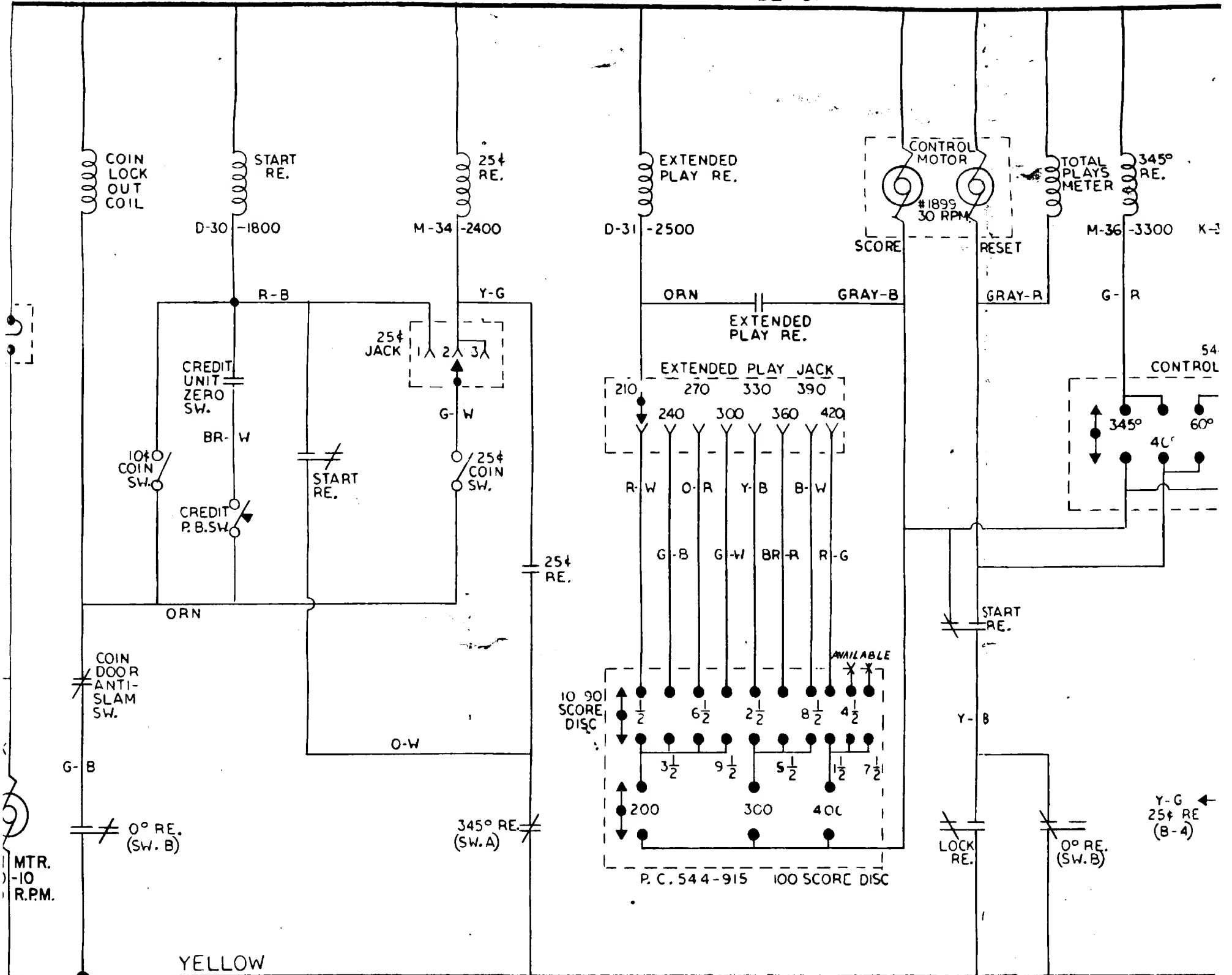

YELLOW

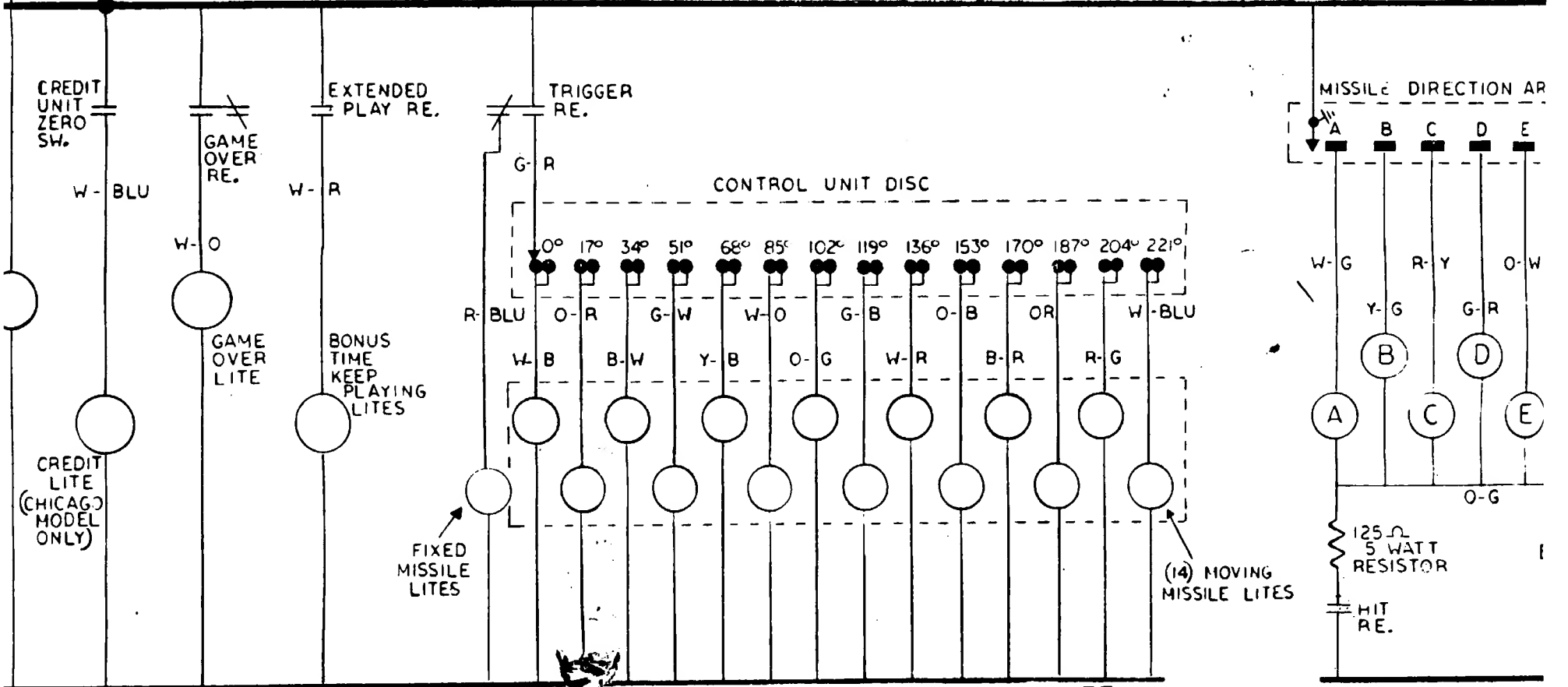

WHITE

WHITE

